

SOP-28L Outline Dimensions

Unit : inches / mm

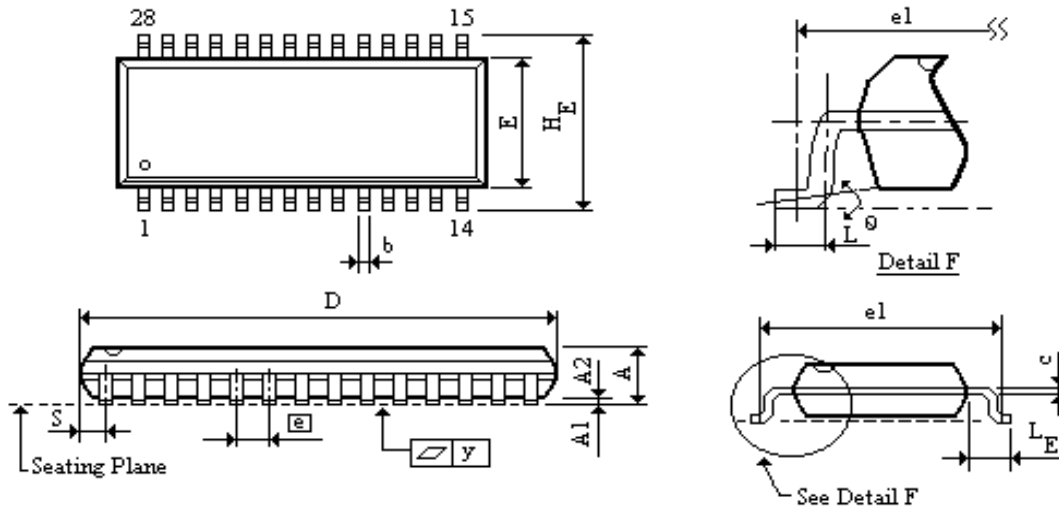

Symbol	Dimensions in inches	Dimensions in mm
A	0.112 Max.	2.85 Max.
A1	0.004 Min.	0.10 Min.
A2	0.098 ±0.005	2.49 ±0.13
b	+0.004 0.016 -0.002	+0.10 0.41 -0.05
C	+0.004 0.010 -0.002	+0.10 0.25 -0.05
D	0.713 Typ. (0.524 Max.)	18.11 Typ. (18.62 Max.)
E	0.331 ±0.010	8.41 ±0.25
e	0.050 ±0.006	1.27 ±0.15
e1	0.429 NOM.	10.90 NOM.
H _E	0.465 ±0.012	11.81 ±0.31
L	0.036 ±0.008	0.91 ±0.20
L _E	0.067 ±0.008	1.70 ±0.20
S	0.047 Max.	1.19 Max.
y	0.006 Max.	0.15 Max.
θ	0° ~ 10°	0° ~ 10°

Notes:

1. The maximum value of dimension D includes end flash.
2. Dimension E1 does not include resin fins.
3. Dimension S includes end flash.
4. All dimensions are based on the British system.